

Serie Series	Systemnummer System number	Bezeichnung	Designation	Abmessungen Dimensions	Seite Page
GCW 050, GCW 060	720001	Glashaltdichtung	Glass support gasket	–	2
GCW 050, GCW 060	720002	Dichtscheibe	Sealing disc	–	2
GCW 050, GCW 060	750004	Verglasungsdichtung	Glazing gasket	4 mm	2
GCW 050, GCW 060	750006	Verglasungsdichtung	Glazing gasket	6 mm	2
GCW 050, GCW 060	750007	Verglasungsdichtung außen	Glazing gasket outside	6 mm	2
GCW 050, GCW 060	750010	Silikon - Fugendichtung	Silicone gap gasket	–	2
GCW 050, GCW 060	750011	Fugendichtung	Gap gasket	–	3
GCW 050	750024	Druckleistendichtteil 4 mm	Pressure strip sealing part 4 mm	4 mm	3
GCW 050	750026	Druckleistendichtteil 6 mm	Pressure strip sealing part 6 mm	6 mm	3
GCW 050, GCW 060	750030	Dehnungsstoßstück	Expansion joint part	–	3
GCW 050, GCW 060	750031	Dehnungsdichtung	Expansion gasket	2 - 2,5 mm	3
GCW 050, GCW 060	750033	Dichtschnur	Sealing cord	4 mm	3
GCW 050	750035	Dichtstück	Sealing piece	–	4
GCW 050, GCW 060	750038	Dehnungsdichtung	Expansion gasket	–	4
GCW 050, GCW 060	750102	Verglasungsdichtung	Glazing gasket	2 mm	4
GCW 050, GCW 060	750203	Verglasungsdichtung innen	Glazing gasket inside	3 mm	4
GCW 050, GCW 060	750205	Verglasungsdichtung	Glazing gasket	5 mm	4
GCW 050, GCW 060	750207	Verglasungsdichtung	Glazing gasket	7 mm	4
GCW 050, GCW 060	750209	Verglasungsdichtung	Glazing gasket	9 mm	5
GCW 050, GCW 060	750211	Verglasungsdichtung	Glazing gasket	11 mm	5
GCW 050, GCW 060	750301	Verglasungsdichtung Außenecke	Glazing gasket outer corner	–	5
GCW 050, GCW 060	750311	Verglasungsdichtung Außenecke	Glazing gasket outer corner	–	5
GCW 050, GCW 060	750331	Verglasungsdichtung Innenecke	Glazing gasket inner corner	–	5
GCW 050, GCW 060	750402	Verglasungsdichtung außen	Glazing gasket outside	2 mm	5
GCW 050, GCW 060	760006	Verglasungsdichtung	Glazing gasket	6 mm	6
GCW 060	760024	Druckleistendichtteil 4 mm	Pressure strip sealing part 4 mm	4 mm	6
GCW 060	760026	Druckleistendichtteil 6 mm	Pressure strip sealing part 6 mm	6 mm	6
GCW 050, GCW 060	760030	Dehnungsstoßstück	Expansion joint part	–	6
GCW 060	760035	Dichtstück	Sealing piece	–	6
GCW 050, GCW 060	760104	Verglasungsdichtung	Glazing gasket	4 mm	7
GCW 050, GCW 060	760104 99	Verglasungsdichtung Rahmen	Glazing gasket frame	4 mm	7
GCW 050, GCW 060	760106	Verglasungsdichtung	Glazing gasket	6 mm	7
GCW 050, GCW 060	760106 99	Verglasungsdichtung Rahmen	Glazing gasket frame	6 mm	7
GCW 050, GCW 060	760108	Verglasungsdichtung	Glazing gasket	8 mm	7
GCW 050, GCW 060	760108 99	Verglasungsdichtung Rahmen	Glazing gasket frame	8 mm	7
GCW 050, GCW 060	760110	Verglasungsdichtung	Glazing gasket	10 mm	8
GCW 050, GCW 060	760110 99	Verglasungsdichtung Rahmen	Glazing gasket frame	10 mm	8
GCW 050, GCW 060	760112	Verglasungsdichtung	Glazing gasket	12 mm	8
GCW 050, GCW 060	760112 99	Verglasungsdichtung Rahmen	Glazing gasket frame	12 mm	8
GCW 050, GCW 060	760114	Verglasungsdichtung	Glazing gasket	14 mm	8
GCW 050, GCW 060	760114 99	Verglasungsdichtung Rahmen	Glazing gasket frame	14 mm	9
GCW 050, GCW 060	760116	Verglasungsdichtung	Glazing gasket	16 mm	9
GCW 050, GCW 060	760116 99	Verglasungsdichtung Rahmen	Glazing gasket frame	16 mm	9
GCW 050, GCW 060	770009	Verglasungsdichtung außen	Glazing gasket outside	1,5 mm	9
GCW 050, GCW 060	770010	Verglasungsdichtung außen	Glazing gasket outside	3,5 mm	9
GCW 050, GCW 060	760104 99	Bestellformular Dichtungsrahmen	Order form gasket frame	4 mm	10
GCW 050, GCW 060	760106 99	Bestellformular Dichtungsrahmen	Order form gasket frame	6 mm	11
GCW 050, GCW 060	760108 99	Bestellformular Dichtungsrahmen	Order form gasket frame	8 mm	12
GCW 050, GCW 060	760110 99	Bestellformular Dichtungsrahmen	Order form gasket frame	10 mm	13
GCW 050, GCW 060	760112 99	Bestellformular Dichtungsrahmen	Order form gasket frame	12 mm	14
GCW 050, GCW 060	760114 99	Bestellformular Dichtungsrahmen	Order form gasket frame	14 mm	15
GCW 050, GCW 060	760116 99	Bestellformular Dichtungsrahmen	Order form gasket frame	16 mm	16

Symbolerklärung | Pictogram declaration

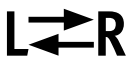

Farbe
Colour



DIN - Richtung
DIN - direction

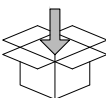

Mengeneinheit
Unit of Quantity

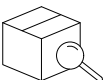

Inhalt Verkaufseinheit
Unit of Sale



Verpackungseinheit
Per Unit



Produktkennzeichen
Product identifier 720001

Produktbezeichnung
Product designation Glashaltdichtung
Glass gasket

Artikelnummer
Item number ZB720001

Für Halterung Semi-SG und SG-Fassade Für fastener Semi-SG and SG curtain wall

Werkstoff Material						Best.Nr. (EAN) Order No. (EAN)
Silikon Silicone	schwarz black		50 m	1 ME	Karton carton	4021036920083

Passend zu Serie | Compatible to series

GCW 050
GCW 060

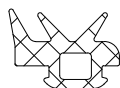

Produktkennzeichen
Product identifier 750006

Produktbezeichnung
Product designation Verglasungsdichtung außen
Outer glazing gasket

Artikelnummer
Item number ZB750006

Für gerade Druckleiste, Spaltbreite c = 6 mm. Für straight pressure strip, gap width c = 6 mm

Werkstoff Material						Best.Nr. (EAN) Order No. (EAN)
EPDM EPDM	schwarz black		100 m	1 ME	Karton carton	4021036529248

Passend zu Serie | Compatible to series

GCW 050
GCW 060



Produktkennzeichen
Product identifier 720002

Produktbezeichnung
Product designation Dichtscheibe
Sealing disc

Artikelnummer
Item number ZB720002

Ø = 11 mm und Stärke 2 mm, Schraubabdeckung für Profil 159313 Ø = 11 mm and thickness 2 mm, screw cover for profile 159313

Werkstoff Material						Best.Nr. (EAN) Order No. (EAN)
Silikon Silicone	schwarz black		100 Stück piece	1 ME	Beutel bag	4021036920106

Passend zu Serie | Compatible to series

GCW 050
GCW 060

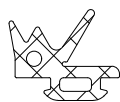

Produktkennzeichen
Product identifier 750007

Produktbezeichnung
Product designation Verglasungsdichtung außen
Glazing gasket outside variable

Artikelnummer
Item number ZB750007

Variable Verglasungsdichtung außen für Polygonfassade, Einsatzbereich 0 - 10°, Spaltbreite c = 6 mm Variable glazing gasket outside for polygonal curtain wall, application range 0 - 10°, gap width c = 6 mm

Werkstoff Material						Best.Nr. (EAN) Order No. (EAN)
EPDM EPDM	schwarz black		100 m	1 ME	Karton carton	4021036920182

Passend zu Serie | Compatible to series

GCW 050
GCW 060

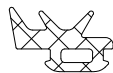





Produktkennzeichen
Product identifier 750004

Produktbezeichnung
Product designation Verglasungsdichtung außen
Outer glazing gasket

Artikelnummer
Item number ZB750004

Für gerade Druckleiste, Spaltbreite c = 4 mm. Für straight pressure strip, gap width c = 4 mm

Werkstoff Material						Best.Nr. (EAN) Order No. (EAN)
EPDM EPDM	schwarz black		100 m	1 ME	Karton carton	4021036529200

Passend zu Serie | Compatible to series

GCW 050
GCW 060







Produktkennzeichen
Product identifier 750010

Produktbezeichnung
Product designation Silikon - Fugendichtung
Silicone gap gasket

Artikelnummer
Item number ZB750010

Äußere Dichtung für Ganz-Glas Fassade Outer gasket for full glass curtain wall

Werkstoff Material						Best.Nr. (EAN) Order No. (EAN)
Silikon Silicone	schwarz black		50 m	1 ME	Karton carton	4021036920250

Passend zu Serie | Compatible to series

GCW 050
GCW 060

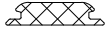

Produktkennzeichen
Product identifier 750011
Produktbezeichnung
Product designation Fugendichtung
Gap gasket
Artikelnummer
Item number ZB750011

Deckt die Schraubenköpfe in der Druckleiste 159311 ab Covers the screw heads in pressure strip 159311

Werkstoff Material						Best.Nr. (EAN) Order No. (EAN)
Silikon Silicone	schwarz black		100 m	1 ME	Karton carton	4021036920267

Passend zu Serie | Compatible to series
GCW 050
GCW 060

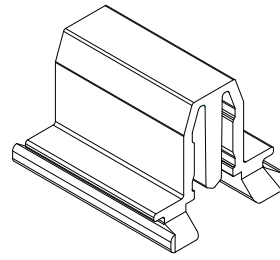

Produktkennzeichen
Product identifier 750030
Produktbezeichnung
Product designation Dehnungsstoßstück
Expansion joint part
Artikelnummer
Item number ZB750030

Einsatz in Pfosten bei Dehnungsstößen Application in mullions at expansion joints

Werkstoff Material						Best.Nr. (EAN) Order No. (EAN)
EPDM EPDM	schwarz black		10 Stück piece	1 ME	Beutel bag	4021036920335

Passend zu Serie | Compatible to series
GCW 050

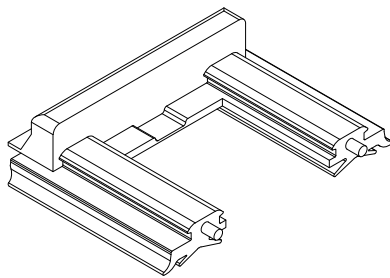

Produktkennzeichen
Product identifier 750024
Produktbezeichnung
Product designation Druckleistendichtteil 4 mm
Pressure strip sealing part 4 mm
Artikelnummer
Item number 750024

Anschlussformteil für Druckleiste 159310 und Dichtung 750004, Spaltbreite c = 4 mm Molded connection part for pressure strip 159310 and gasket 750004, gap width c = 4 mm

Werkstoff Material						Best.Nr. (EAN) Order No. (EAN)
Silikon Silicone	schwarz black		20 Stück piece	1 ME	Beutel bag	4021036529231

Passend zu Serie | Compatible to series
GCW 050

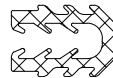

Produktkennzeichen
Product identifier 750031
Produktbezeichnung
Product designation Dehnungsdichtung
Expansion gasket
Artikelnummer
Item number ZB750031

Verbindung von Dehnprofilen mit Blecheinlage, Blechdicke: 2 - 2,5 mm Connection of expansion profiles with metal sheet inserts, sheet thickness: 2 - 2,5 mm

Werkstoff Material						Best.Nr. (EAN) Order No. (EAN)
EPDM EPDM	schwarz black		100 m	1 ME	Karton carton	4021036920342

Passend zu Serie | Compatible to series
GCW 050
GCW 060

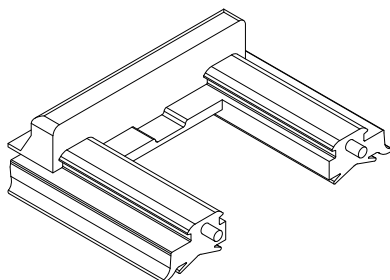

Produktkennzeichen
Product identifier 750026
Produktbezeichnung
Product designation Druckleistendichtteil 6 mm
Pressure strip sealing part 6 mm
Artikelnummer
Item number ZB750026

Anschlussformteil für Druckleiste 159310 und Dichtung 750006, Spaltbreite c = 6 mm Molded connection part for pressure strip 159310 and gasket 750006, gap width c = 6 mm

Werkstoff Material						Best.Nr. (EAN) Order No. (EAN)
Silikon Silicone	schwarz black		20 Stück piece	1 ME	Beutel bag	4021036529255

Passend zu Serie | Compatible to series
GCW 050



Produktkennzeichen
Product identifier 750033
Produktbezeichnung
Product designation Dichtschnur
Round cord
Artikelnummer
Item number ZB750033

Dichtschnur aus Moosgummi für diverse Anwendungen und Einsatzbereiche Sealing cord made of foam rubber for various applications and areas of use

Werkstoff Material						Best.Nr. (EAN) Order No. (EAN)
EPDM EPDM	schwarz black		100 m	1 ME	Beutel bag	4021036527503

Passend zu Serie | Compatible to series
GCW 050
GCW 060

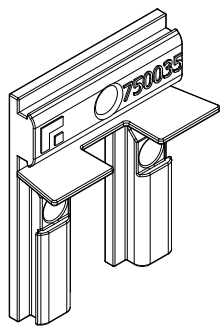

Produktkennzeichen Product identifier	750035
Produktbezeichnung Product designation	Dichtstück Sealing piece
Artikelnummer Item number	E005270

Werkstoff Material						Best.Nr. (EAN) Order No. (EAN)
EPDM EPDM	schwarz black		100 Stück 100 piece	1 ME	Beutel bag	4021036873587

Passend zu Serie | Compatible to series
GCW 050

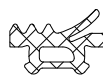

Produktkennzeichen Product identifier	750203
Produktbezeichnung Product designation	Verglasungsdichtung innen Inner glazing gasket
Artikelnummer Item number	ZB750203

Innere Verglasungsdichtung, Spaltbreite c = 3 mm, Füllstärken nach Glastabelle
Inner glazing gasket, gap width c = 3 mm, see glazing table for filling thickness

Werkstoff Material						Best.Nr. (EAN) Order No. (EAN)
EPDM EPDM	schwarz black		200 m	1 ME	Karton carton	4021036920526

Passend zu Serie | Compatible to series
GCW 050
GCW 060

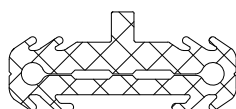

Produktkennzeichen Product identifier	750038
Produktbezeichnung Product designation	Dehnungsdichtung Expansion gasket
Artikelnummer Item number	ZB750038

Verbindung von Dehnprofilen
Connection of expansion profiles

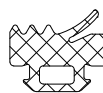

Werkstoff Material						Best.Nr. (EAN) Order No. (EAN)
EPDM EPDM	schwarz black		50 m	1 ME	Karton carton	4021036920397

Passend zu Serie | Compatible to series
GCW 050
GCW 060



Produktkennzeichen Product identifier	750205
Produktbezeichnung Product designation	Verglasungsdichtung Glazing gasket
Artikelnummer Item number	ZB750205

Innere Verglasungsdichtung, Spaltbreite c = 5 mm, Füllstärken nach Glastabelle
Inner glazing gasket, gap width c = 5 mm, see glazing table for filling thickness





Werkstoff Material						Best.Nr. (EAN) Order No. (EAN)
EPDM EPDM	schwarz black		100 m	1 ME	Karton carton	4021036920533

Passend zu Serie | Compatible to series
GCW 050
GCW 060



Produktkennzeichen Product identifier	750102
Produktbezeichnung Product designation	Verglasungsdichtung Glazing gasket
Artikelnummer Item number	ZB750102

Innere Verglasungsdichtung, Spaltbreite c = 2 mm, Füllstärken nach Glastabelle
Inner glazing gasket, gap width c = 2 mm, see glazing table for filling thickness



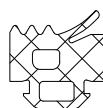

Werkstoff Material						Best.Nr. (EAN) Order No. (EAN)
EPDM EPDM	schwarz black		100 m	1 ME	Karton carton	4021036838494

Passend zu Serie | Compatible to series
GCW 050
GCW 060



Produktkennzeichen Product identifier	750207
Produktbezeichnung Product designation	Verglasungsdichtung Glazing gasket
Artikelnummer Item number	ZB750207

Innere Verglasungsdichtung, Spaltbreite c = 7 mm, Füllstärken nach Glastabelle
Inner glazing gasket, gap width c = 7 mm, see glazing table for filling thickness

Werkstoff Material						Best.Nr. (EAN) Order No. (EAN)
EPDM EPDM	schwarz black		100 m	1 ME	Karton carton	4021036920540

Passend zu Serie | Compatible to series
GCW 050
GCW 060

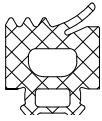

Produktkennzeichen
Product identifier **750209**

Produktbezeichnung
Product designation **Verglasungsdichtung**
Glazing gasket

Artikelnummer
Item number **ZB750209**

Innere Verglasungsdichtung, Spaltbreite c = 9 mm, Füllstärken nach Glastabelle
Inner glazing gasket, gap width c = 9 mm, see glazing table for filling thickness

Werkstoff Material						Best.Nr. (EAN) Order No. (EAN)
EPDM EPDM	schwarz black		50 m	1 ME	Karton carton	4021036920564

Passend zu Serie | Compatible to series
GCW 050
GCW 060

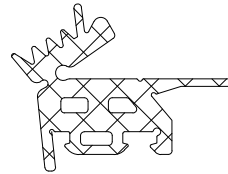

Produktkennzeichen
Product identifier **750311**

Produktbezeichnung
Product designation **Verglasungsdichtung Außenecke**
Glazing gasket for outer corner

Artikelnummer
Item number **ZB750311**

Innere Pfostendichtung für Polygonfassade, Einsatzbereich 10 - 45° Außenecke, Füllstärke nach Glastabellen
Inner mullion gasket, for polygon curtain walls, application range 10 - 45° outside corner, see glazing tables for filling thicknesses

Werkstoff Material						Best.Nr. (EAN) Order No. (EAN)
EPDM EPDM	schwarz black		50 m	1 ME	Karton carton	4021036921103

Passend zu Serie | Compatible to series
GCW 050
GCW 060

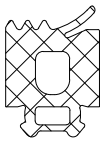

Produktkennzeichen
Product identifier **750211**

Produktbezeichnung
Product designation **Verglasungsdichtung**
Glazing gasket

Artikelnummer
Item number **ZB750211**

Innere Verglasungsdichtung, Spaltbreite c = 11 mm, Füllstärken nach Glastabelle
Inner glazing gasket, gap width c = 11 mm, see glazing table for filling thickness

Werkstoff Material						Best.Nr. (EAN) Order No. (EAN)
EPDM EPDM	schwarz black		50 m	1 ME	Karton carton	4021036920588

Passend zu Serie | Compatible to series
GCW 050
GCW 060

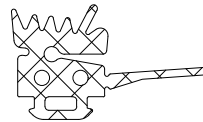

Produktkennzeichen
Product identifier **750331**

Produktbezeichnung
Product designation **Verglasungsdichtung Innenecke**
Glazing gasket inner corner

Artikelnummer
Item number **ZB750331**

Innere Pfostendichtung für Polygonfassade, Einsatzbereich 0 - 10° Innenecke, Füllstärke nach Glastabellen
Inner mullion gasket, for polygon curtain walls, application range 0 - 10° inside corner, see glazing tables for filling thicknesses

Werkstoff Material						Best.Nr. (EAN) Order No. (EAN)
EPDM EPDM	schwarz black		100 m	1 ME	Karton carton	4021036921172

Passend zu Serie | Compatible to series
GCW 050
GCW 060

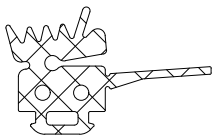

Produktkennzeichen
Product identifier **750301**

Produktbezeichnung
Product designation **Verglasungsdichtung Außenecke**
Glazing gasket for outer corner

Artikelnummer
Item number **ZB750301**

Innere Pfostendichtung für Polygonfassade, Einsatzbereich 0 - 10° Außenecke, Füllstärke nach Glastabellen
Inner mullion gasket, for polygon curtain walls, application range 0 - 10° outside corner, see glazing tables for filling thicknesses

Werkstoff Material						Best.Nr. (EAN) Order No. (EAN)
EPDM EPDM	schwarz black		100 m	1 ME	Karton carton	4021036921080

Passend zu Serie | Compatible to series
GCW 050
GCW 060



Produktkennzeichen
Product identifier **750402**

Produktbezeichnung
Product designation **Verglasungsdichtung außen**
Glazing gasket outside

Artikelnummer
Item number **ZB750402**



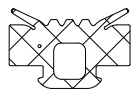

Für Dachverglasung im Riegelbereich, Spaltbreite c = 2 mm
External glazing gasket for roof glazing around transoms, gap size c = 2 mm

Werkstoff Material						Best.Nr. (EAN) Order No. (EAN)
EPDM EPDM	schwarz black		50 m	1 ME	Karton carton	4021036921134

Passend zu Serie | Compatible to series
GCW 050
GCW 060



Produktkennzeichen Product identifier	760006
Produktbezeichnung Product designation	Verglasungsdichtung Glazing gasket
Artikelnummer Item number	E005265

Werkstoff Material						Best.Nr. (EAN) Order No. (EAN)
EPDM EPDM	schwarz black		100 m	1 ME	Karton carton	4021036866091

Passend zu Serie | Compatible to series

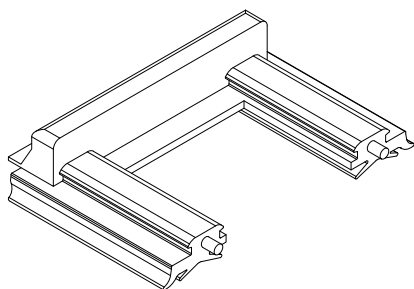
 GCW 050
 GCW 060

Produktkennzeichen Product identifier	760024
Produktbezeichnung Product designation	Druckleistendichtteil Pressure strip sealing piece
Artikelnummer Item number	ZB760024
Anschlussformteil für Druckleiste 159310 und Dichtung 750004 Spaltbreite c = 4 mm	Molded connection part for pressure strip 159310 and gasket 750004 gap width c = 4 mm

Werkstoff Material						Best.Nr. (EAN) Order No. (EAN)
EPDM EPDM	schwarz black		20 Stück piece	1 ME	Beutel bag	4021036526032

Passend zu Serie | Compatible to series

GCW 060

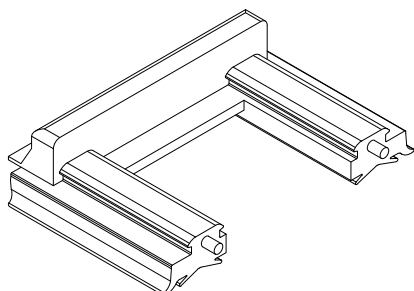

Produktkennzeichen Product identifier	760026
Produktbezeichnung Product designation	Druckleistendichtteil Pressure strip sealing piece
Artikelnummer Item number	ZB760026
Anschlussformteil für Druckleiste 159310 und Dichtung 750006 Spaltbreite c = 6 mm	Molded connection part for pressure strip 159310 and gasket 750006 gap width c = 6 mm

Werkstoff Material						Best.Nr. (EAN) Order No. (EAN)
EPDM EPDM	schwarz black		20 Stück piece	1 ME	Beutel bag	4021036287896

Passend zu Serie | Compatible to series

GCW 060

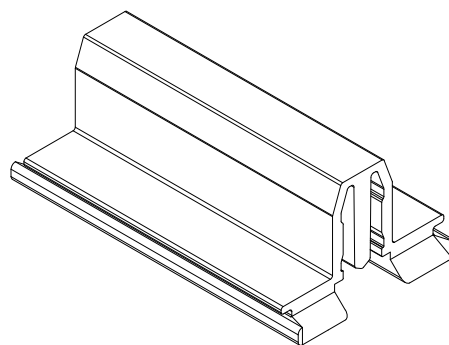

Produktkennzeichen Product identifier	760030
Produktbezeichnung Product designation	Dehnungsstoßstück Expansion joint part
Artikelnummer Item number	ZB760030

Einsatz in Pfosten bei Dehnungsstößen

Application in Mullions expansion joints

Werkstoff Material						Best.Nr. (EAN) Order No. (EAN)
EPDM EPDM	schwarz black		10 Stück piece	1 ME	Beutel bag	4021036921424

Passend zu Serie | Compatible to series

GCW 060

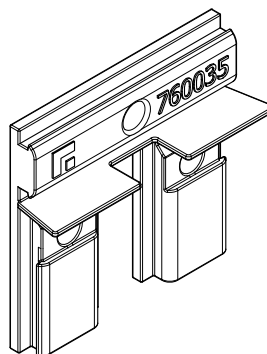

Produktkennzeichen Product identifier	760035
Produktbezeichnung Product designation	Dichtstück Sealing piece
Artikelnummer Item number	E005271

Werkstoff Material						Best.Nr. (EAN) Order No. (EAN)
EPDM EPDM	schwarz black		100 Stück 100 piece	1 ME	Beutel bag	4021036873655

Passend zu Serie | Compatible to series

GCW 060



Produktkennzeichen
Product identifier **760104**

Produktbezeichnung
Product designation **Verglasungsdichtung**
Glazing gasket

Artikelnummer
Item number **E005444**

Innere Verglasungsdichtung, Spaltbreite c = 4 mm, Füllstärken nach Glastabelle
Inner glazing gasket, gap width c = 4 mm, see glazing table for filling thickness

Werkstoff Material						Best.Nr. (EAN) Order No. (EAN)
EPDM EPDM	schwarz black	100 m	1 ME	Karton carton		4021036931430

Passend zu Serie | Compatible to series
GCW 050
GCW 060

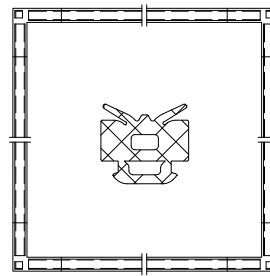

Produktkennzeichen
Product identifier **760106 99**

Produktbezeichnung
Product designation **Dichtungsrahmen**
Gasket frame

Artikelnummer
Item number **E005592**

Rahmen aus Dichtung 760106
Frame made of gasket 760106

Werkstoff Material						Best.Nr. (EAN) Order No. (EAN)
EPDM EPDM	schwarz black	1 Stück piece	1 ME	Karton carton		4021036983798

Passend zu Serie | Compatible to series
GCW 050
GCW 060

Nur auf Anfrage! | Upon request!

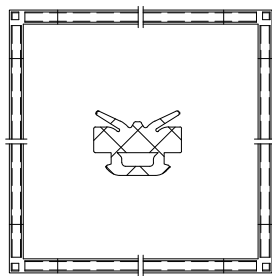

Produktkennzeichen
Product identifier **760104 99**

Produktbezeichnung
Product designation **Dichtungsrahmen**
Gasket frame

Artikelnummer
Item number **E005593**

Rahmen aus Dichtung 760104
Frame made of gasket 760104

Werkstoff Material						Best.Nr. (EAN) Order No. (EAN)
EPDM EPDM	schwarz black	1 Stück piece	1 ME	Karton carton		4021036983804

Passend zu Serie | Compatible to series
GCW 050
GCW 060

Nur auf Anfrage! | Upon request!

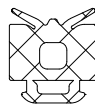

Produktkennzeichen
Product identifier **760108**

Produktbezeichnung
Product designation **Verglasungsdichtung**
Glazing gasket

Artikelnummer
Item number **E005446**

Innere Verglasungsdichtung, Spaltbreite c = 8 mm, Füllstärken nach Glastabelle
Inner glazing gasket, gap width c = 8 mm, see glazing table for filling thickness

Werkstoff Material						Best.Nr. (EAN) Order No. (EAN)
EPDM EPDM	schwarz black	100 m	1 ME	Karton carton		4021036931645

Passend zu Serie | Compatible to series
GCW 050
GCW 060

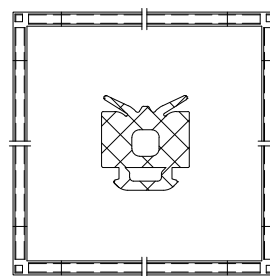

Produktkennzeichen
Product identifier **760108 99**

Produktbezeichnung
Product designation **Dichtungsrahmen**
Gasket frame

Artikelnummer
Item number **E005594**

Rahmen aus Dichtung 760108
Frame made of gasket 760108

Werkstoff Material						Best.Nr. (EAN) Order No. (EAN)
EPDM EPDM	schwarz black	1 Stück piece	1 ME	Karton carton		4021036983811

Passend zu Serie | Compatible to series
GCW 050
GCW 060

Nur auf Anfrage! | Upon request!



Produktkennzeichen
Product identifier **760106**

Produktbezeichnung
Product designation **Verglasungsdichtung**
Glazing gasket

Artikelnummer
Item number **E005445**

Innere Verglasungsdichtung, Spaltbreite c = 6 mm, Füllstärken nach Glastabelle
Inner glazing gasket, gap width c = 6 mm, see glazing table for filling thickness

Werkstoff Material						Best.Nr. (EAN) Order No. (EAN)
EPDM EPDM	schwarz black	100 m	1 ME	Karton carton		4021036931461

Passend zu Serie | Compatible to series
GCW 050
GCW 060

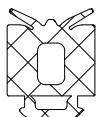

Produktkennzeichen
Product identifier

760110

Produktbezeichnung
Product designation





Verglasungsdichtung
Glazing gasket

Artikelnummer
Item number

E005263

Innere Verglasungsdichtung, Spaltbreite
c = 10 mm, Füllstärken nach Glastabelle

Inner glazing gasket, gap width c = 10 mm,
see glazing table for filling thickness

Werkstoff Material						Best.Nr. (EAN) Order No. (EAN)
EPDM	schwarz black		100 m	1 ME	Karton carton	4021036866077

Passend zu Serie | Compatible to series

GCW 050
GCW 060

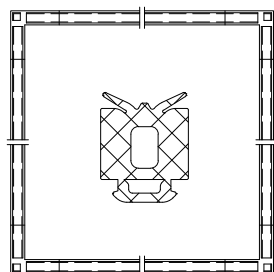

Produktkennzeichen
Product identifier

760110 99

Produktbezeichnung
Product designation

Dichtungsrahmen
Gasket frame

Artikelnummer
Item number

E005454

Rahmen aus Dichtung 760110

Frame made of gasket 760110

Werkstoff Material						Best.Nr. (EAN) Order No. (EAN)
EPDM	schwarz black		1 Stück piece	1 ME	Karton carton	4021036891994

Passend zu Serie | Compatible to series

GCW 050
GCW 060

Nur auf Anfrage! | Upon request!

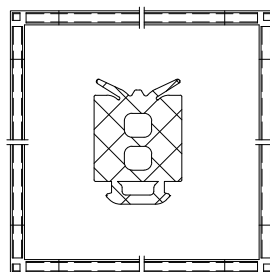

Produktkennzeichen
Product identifier

760112 99

Produktbezeichnung
Product designation

Dichtungsrahmen
Gasket frame

Artikelnummer
Item number

E005591

Rahmen aus Dichtung 760112

Frame made of gasket 760112

Werkstoff Material						Best.Nr. (EAN) Order No. (EAN)
EPDM	schwarz black		1 Stück piece	1 ME	Karton carton	4021036983781

Passend zu Serie | Compatible to series

GCW 050
GCW 060

Nur auf Anfrage! | Upon request!

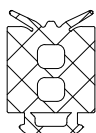

Produktkennzeichen
Product identifier

760112

Produktbezeichnung
Product designation





Verglasungsdichtung
Glazing gasket

Artikelnummer
Item number

E005447

Innere Verglasungsdichtung, Spaltbreite
c = 12 mm, Füllstärken nach Glastabelle

Inner glazing gasket, gap width c = 12 mm, see glazing
table for filling thickness

Werkstoff Material						Best.Nr. (EAN) Order No. (EAN)
EPDM	schwarz black		100 m	1 ME	Karton carton	4021036931676

Passend zu Serie | Compatible to series

GCW 050
GCW 060

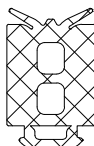

Produktkennzeichen
Product identifier

760114

Produktbezeichnung
Product designation

Verglasungsdichtung
Glazing gasket

Artikelnummer
Item number

E005448

Innere Verglasungsdichtung, Spaltbreite
c = 14 mm, Füllstärken nach Glastabelle

Inner glazing gasket, gap width c = 14 mm, see glazing
table for filling thickness

Werkstoff Material						Best.Nr. (EAN) Order No. (EAN)
EPDM	schwarz black		50 m	1 ME	Karton carton	4021036931683

Passend zu Serie | Compatible to series

GCW 050
GCW 060

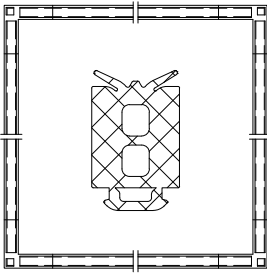

Produktkennzeichen
Product identifier
760114 99

Produktbezeichnung
Product designation
Dichtungsrahmen
Gasket frame

Artikelnummer
Item number
E005595

Rahmen aus Dichtung 760114
Frame made of gasket 760114

Werkstoff Material						Best.Nr. (EAN) Order No. (EAN)
EPDM EPDM	schwarz black		1 Stück piece	1 ME	Karton carton	4021036983828

Passend zu Serie | Compatible to series
GCW 050
GCW 060

Nur auf Anfrage! | Upon request!

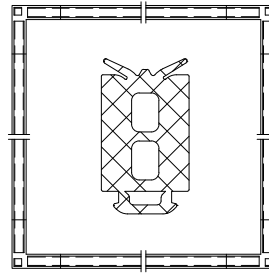

Produktkennzeichen
Product identifier
760116 99

Produktbezeichnung
Product designation
Dichtungsrahmen
Gasket frame

Artikelnummer
Item number
E005596

Rahmen aus Dichtung 760116
Frame made of gasket 760116

Werkstoff Material						Best.Nr. (EAN) Order No. (EAN)
EPDM EPDM	schwarz black		1 Stück piece	1 ME	Karton carton	4021036983835

Passend zu Serie | Compatible to series
GCW 050
GCW 060

Nur auf Anfrage! | Upon request!

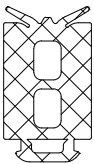

Produktkennzeichen
Product identifier
760116

Produktbezeichnung
Product designation
Verglasungsdichtung
Glazing gasket

Artikelnummer
Item number
E005449

Innere Verglasungsdichtung, Spaltbreite
c = 16 mm, Füllstärken nach Glastabelle
Inner glazing gasket, gap width c = 16 mm, see glazing
table for filling thickness

Werkstoff Material						Best.Nr. (EAN) Order No. (EAN)
EPDM EPDM	schwarz black		50 m	1 ME	Karton carton	4021036931843

Passend zu Serie | Compatible to series
GCW 050
GCW 060



Produktkennzeichen
Product identifier
770009

Produktbezeichnung
Product designation
Verglasungsdichtung außen
Outer glazing gasket

Artikelnummer
Item number
ZB770009

Spaltbreite c = 2 mm
Gap width c = 1,5 mm

Werkstoff Material						Best.Nr. (EAN) Order No. (EAN)
Silikon Silicone	schwarz black		50 m	1 ME	Karton carton	4021036921929

Passend zu Serie | Compatible to series
GCW 050
GCW 060

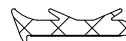

Produktkennzeichen
Product identifier
770010

Produktbezeichnung
Product designation
Verglasungsdichtung außen
Glazing gasket outside

Artikelnummer
Item number
ZB770010

Spaltbreite c = 3,5 mm
Gap width c = 3,5 mm

Werkstoff Material						Best.Nr. (EAN) Order No. (EAN)
Silikon Silicone	schwarz black		50 m	1 ME	Karton carton	4021036921936

Passend zu Serie | Compatible to series
GCW 050
GCW 060

BESTELLFORMULAR | ORDER FORM:
Dichtungsrahmen 760104 99 aus Dichtung 760104
Gasket frame 760104 99 made of gasket 760104

- PREISANFRAGE | PRICE INQUIRY**
 BESTELLUNG | ORDER

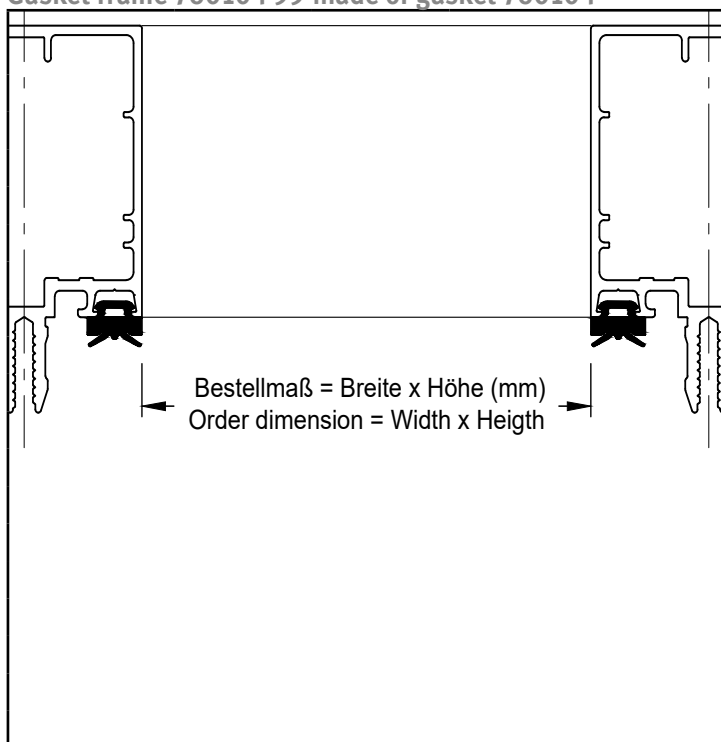

Position Position	Stück Quantity	Breite (mm) Width (mm)	Höhe (mm) Height (mm)

Objekt Nr. Object no.	Objektbezeichnung Object description

Gewünschter Liefertermin (TT.MM.JJJJ) Desired delivery date (DD.MM.YYYY)

Lieferadresse: Delivery address:	Land Country	PLZ Post code	ORT City	Straße Street	Nr. No.

Kunden-Nr.: Customer no:	Kundenname: Customer name:	Ansprechpartner: Contact person:	Telefon / Durchwahl: Telephone / extension:	em@il



GUTMANN Bausysteme GmbH
Nürnberger Straße 57
D-91781 Weißenburg i. Bay.

FAX: +49 (9141) 992 - 620
TEL: +49 (9141) 992 - 0

BESTELLFORMULAR | ORDER FORM:
Dichtungsrahmen 760106 99 aus Dichtung 760106
Gasket frame 760106 99 made of gasket 760106

- PREISANFRAGE | PRICE INQUIRY
- BESTELLUNG | ORDER

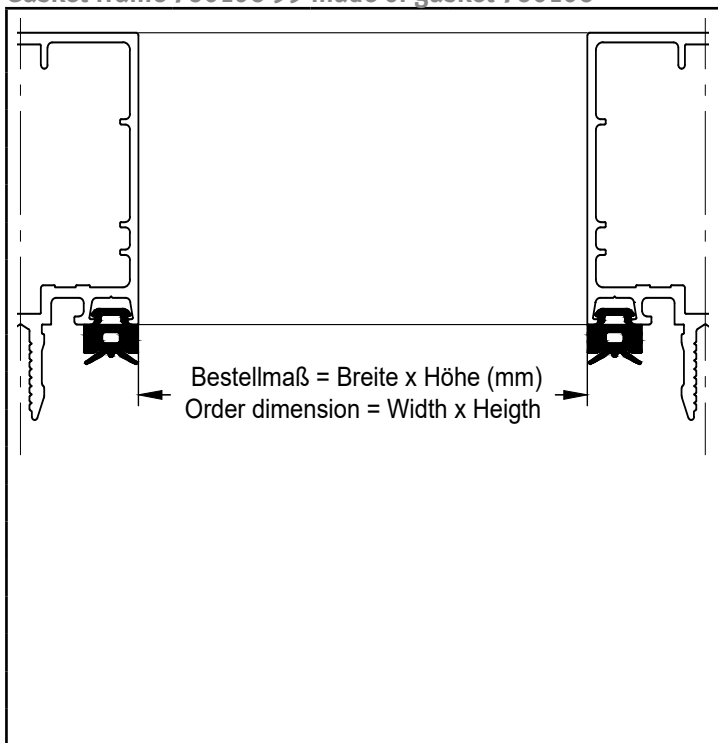

Position Position	Stück Quantity	Breite (mm) Width (mm)	Höhe (mm) Height (mm)

Objekt Nr. Object no.	Objektbezeichnung Object description

Gewünschter Liefertermin (TT.MM.JJJJ) Desired delivery date (DD.MM.YYYY)

Lieferadresse: Delivery address:	Land Country	PLZ Post code	ORT City	Straße Street	Nr. No.

Kunden-Nr.: Customer no:	Kundenname: Customer name:	Ansprechpartner: Contact person:	Telefon / Durchwahl: Telephone / extension:	em@il

 **GUTMANN Bausysteme GmbH**
Nürnberger Straße 57
D-91781 Weißenburg i. Bay.
FAX: +49 (9141) 992 - 620
TEL: +49 (9141) 992 - 0



BESTELLFORMULAR | ORDER FORM:
Dichtungsrahmen 760108 99 aus Dichtung 760108
Gasket frame 760108 99 made of gasket 760108

PREISANFRAGE | PRICE INQUIRY
 BESTELLUNG | ORDER

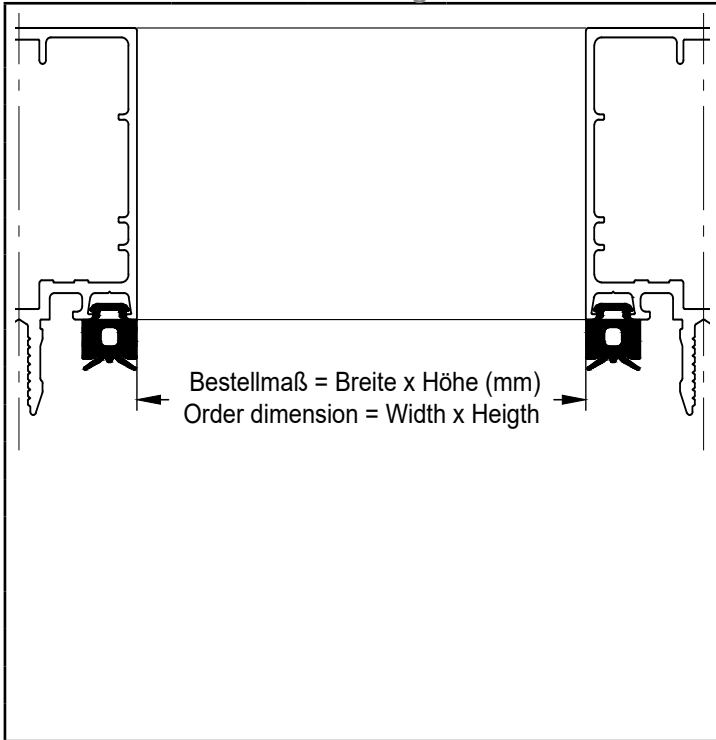

Position Position	Stück Quantity	Breite (mm) Width (mm)	Höhe (mm) Height (mm)

Objekt Nr. Object no.	Objektbezeichnung Object description

Gewünschter Liefertermin (TT.MM.JJJJ) Desired delivery date (DD.MM.YYYY)

Lieferadresse: Delivery address:	Land Country	PLZ Post code	ORT City	Straße Street	Nr. No.

Kunden-Nr.: Customer no:	Kundenname: Customer name:	Ansprechpartner: Contact person:	Telefon / Durchwahl: Telephone / extension:	em@il



GUTMANN Bausysteme GmbH
Nürnberger Straße 57
D-91781 Weißenburg i. Bay.
FAX: +49 (9141) 992 - 620
TEL: +49 (9141) 992 - 0

BESTELLFORMULAR | ORDER FORM:
Dichtungsrahmen 760110 99 aus Dichtung 760110
Gasket frame 760110 99 made of gasket 760110

- PREISANFRAGE | PRICE INQUIRY**
 BESTELLUNG | ORDER

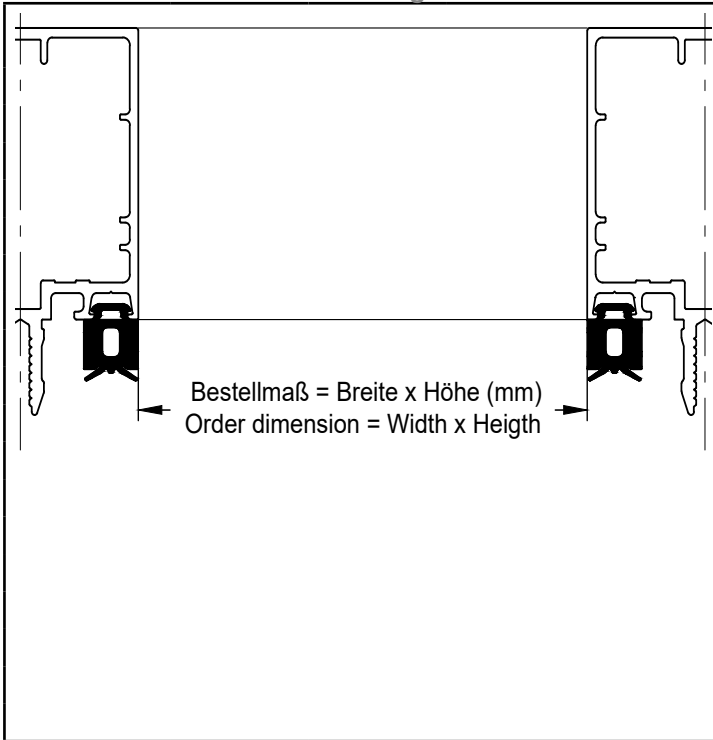

Position Position	Stück Quantity	Breite (mm) Width (mm)	Höhe (mm) Heighth (mm)

Objekt Nr. Object no.	Objektbezeichnung Object description

Gewünschter Liefertermin (TT.MM.JJJJ) Desired delivery date (DD.MM.YYYY)

Lieferadresse: Delivery address:	Land Country	PLZ Post code	ORT City	Straße Street	Nr. No.

Kunden-Nr.: Customer no:	Kundenname: Customer name:	Ansprechpartner: Contact person:	Telefon / Durchwahl: Telephone / extension:	em@il

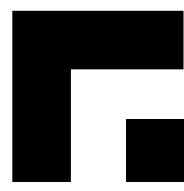

GUTMANN Bausysteme GmbH
Nürnberger Straße 57
D-91781 Weißenburg i. Bay.

FAX: +49 (9141) 992 - 620
TEL: +49 (9141) 992 - 0

G U T M A N N



BESTELLFORMULAR | ORDER FORM:
Dichtungsrahmen 760112 99 aus Dichtung 760112
Gasket frame 760112 99 made of gasket 760112

- PREISANFRAGE | PRICE INQUIRY**
 BESTELLUNG | ORDER

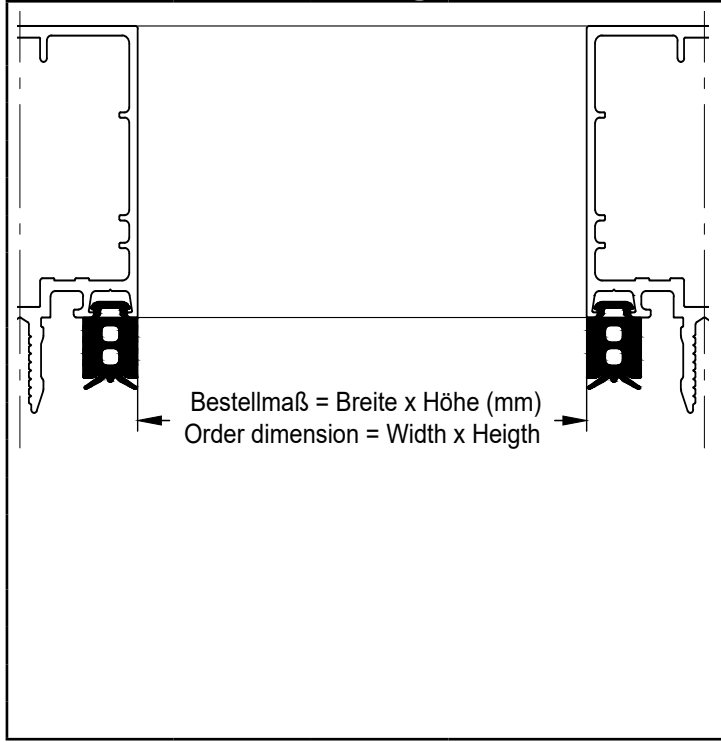

Position Position	Stück Quantity	Breite (mm) Width (mm)	Höhe (mm) Height (mm)

Objekt Nr. Object no.	Objektbezeichnung Object description

Gewünschter Liefertermin (TT.MM.JJJJ) Desired delivery date (DD.MM.YYYY)

Lieferadresse: Delivery address:	Land Country	PLZ Post code	ORT City	Straße Street	Nr. No.

Kunden-Nr.: Customer no:	Kundenname: Customer name:	Ansprechpartner: Contact person:	Telefon / Durchwahl: Telephone / extension:	em@il

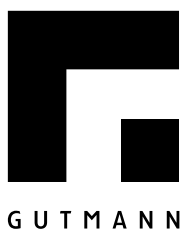

GUTMANN Bausysteme GmbH
 Nürnberger Straße 57
 D-91781 Weißenburg i. Bay.
 FAX: +49 (9141) 992 - 620
 TEL: +49 (9141) 992 - 0

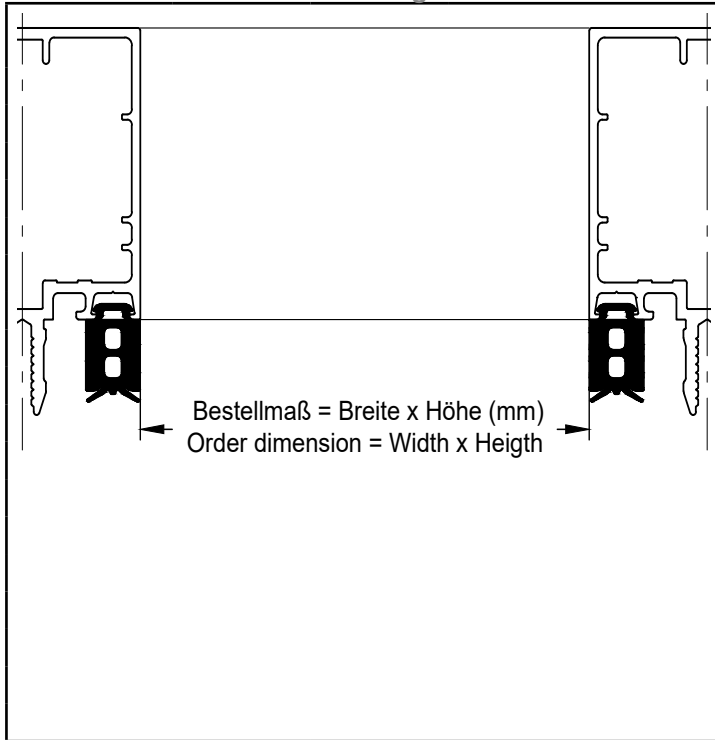
BESTELLFORMULAR | ORDER FORM:
Dichtungsrahmen 760114 99 aus Dichtung 760114
Gasket frame 760114 99 made of gasket 760114
 PREISANFRAGE | PRICE INQUIRY
 BESTELLUNG | ORDER

Position Position	Stück Quantity	Breite (mm) Width (mm)	Höhe (mm) Height (mm)

Objekt Nr. Object no.	Objektbezeichnung Object description

Gewünschter Liefertermin (TT.MM.JJJJ) Desired delivery date (DD.MM.YYYY)

Lieferadresse: Delivery address:	Land Country	PLZ Post code	ORT City	Straße Street	Nr. No.

Kunden-Nr.: Customer no:	Kundenname: Customer name:	Ansprechpartner: Contact person:	Telefon / Durchwahl: Telephone / extension:	em@il

GUTMANN Bausysteme GmbH
 Nürnberger Straße 57
 D-91781 Weißenburg i. Bay.

 FAX: +49 (9141) 992 - 620
 TEL: +49 (9141) 992 - 0

BESTELLFORMULAR | ORDER FORM:

Dichtungsrahmen 760116 99 aus Dichtung 760116

Gasket frame 760116 99 made of gasket 760116

- PREISANFRAGE | PRICE INQUIRY
 BESTELLUNG | ORDER

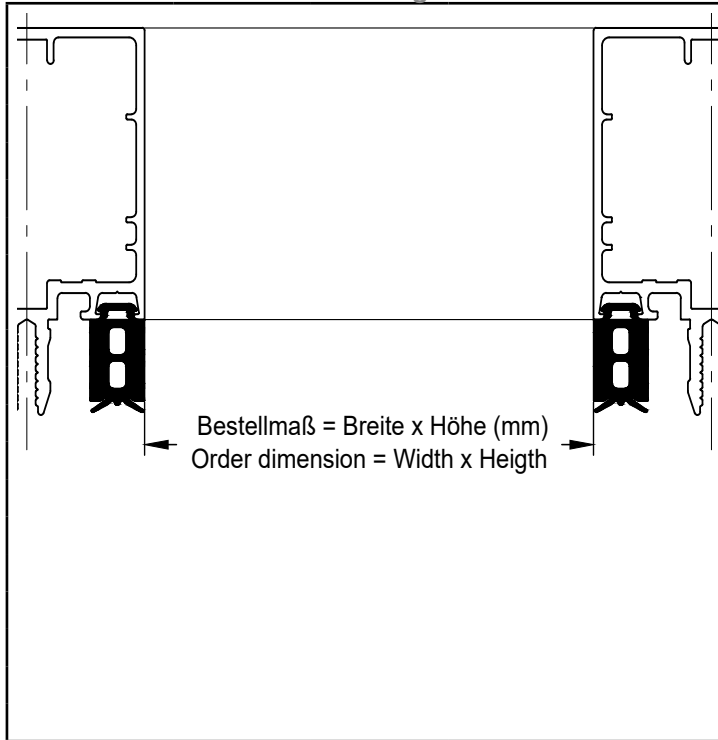

Position Position	Stück Quantity	Breite (mm) Width (mm)	Höhe (mm) Height (mm)

Objekt Nr. Object no.	Objektbezeichnung Object description

Gewünschter Liefertermin (TT.MM.JJJJ) Desired delivery date (DD.MM.YYYY)

Lieferadresse: Delivery address:	Land Country	PLZ Post code	ORT City	Straße Street	Nr. No.

Kunden-Nr.: Customer no:	Kundenname: Customer name:	Ansprechpartner: Contact person:	Telefon / Durchwahl: Telephone / extension:	em@il



G U T M A N N

GUTMANN Bausysteme GmbH
Nürnberger Straße 57
D-91781 Weißenburg i. Bay.

FAX: +49 (9141) 992 - 620
TEL: +49 (9141) 992 - 0